

# APB.L

# APB LASER-CUT



- Accepts GH concealable panels
- Front-opening professional design with laser-cut MOLLE and dual discrete chest pockets
- Optional horizontal and vertical badge grommets on wearer's left chest
- Optional 3x3" or shield shape loop for badge attachment on wearer's left chest
- Optional 1" loop for name tape on wearer's right chest
- Durable high-quality Cordura nylon outer material
- Overlapping shoulder and side closures for extra adjustability utilizing durable high-profile hook and loop
- 5x8" front trauma plate pocket (size restrictions apply)
- 8x10" and 10x12" front and rear rifle plate pockets (size restrictions apply)
- Rear 3x10" loop for ID attachment (IDs sold separately)
- Rear telescoping drag strap for emergency extraction
- Mic tabs at shoulder epaulets and center chest
- Internal cummerbund for secure fit
- Easy and secure body-side panel access
- Ballistic suspension for proper panel alignment prevents sagging and curling

## FEATURES



BACK



SIDE



NAME TAPE



BADGE LOOP

## COLORS



BLACK



DARK NAVY



RANGER GREEN



COYOTE



WOLF GREY



TAN 499



BROWN



SPRUCE GREEN



TACTICAL GREEN

### APB CARRIERS: APB.U, APB.M, APB.L, APB.UM, APB.UL



APB.U	APB.M	APB.L	APB.UM	APB.UL
APB Carrier Uniform	APB Carrier MOLLE	APB Carrier Laser-cut MOLLE	APB Carrier Uniform MOLLE	APB Carrier Uniform Laser-cut MOLLE

#### How to order an APB Style Carrier

There are 8 standard configurations for APB stlye carrier.

Configurations 1-8 are available on all styles of the APB: APB.U, APB.M, APB.L, APB.UM, APB.UL.

#### Configuration 1 (Default)

Left Chest  
4-way Grommets  
3x3 Badge Loop

Right Chest  
Name Tape Loop

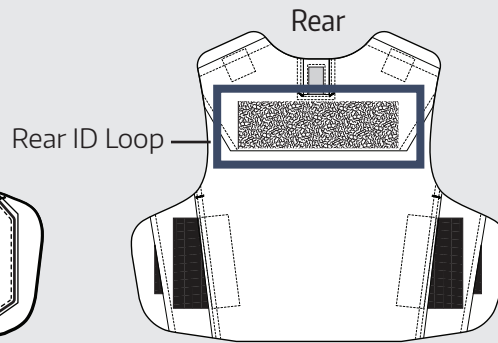
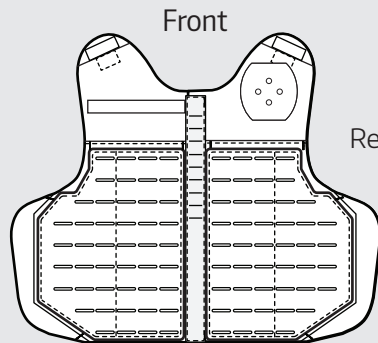

Rear ID Loop is a default feature that can be removed.

No Rear ID Loop = NRL

Please note your desired carrier configuration on the PO.

Ex. APB.L (Black, Configuration 2, NRL) John Smith, size 2413/2415

If no configuration is selected at time of order, the carrier will be entered with Configuration 1, All Features.

#### Embellishment Details

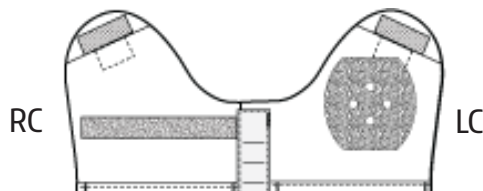

Left Chest and Right Chest notations are viewed as the wearer's left chest and wearer's right chest.

Name Tape: Male 1x5", Female 1x4"  
(Male sizes 16xx and 18xx are restricted to 1x4")

Badge Loop: 3x3" with curved edges,  
3x3" oval shape

Grommets: 1.25" apart on center

ID Loop: Male 3x10", Female 3x9"

### APB CARRIERS: APB.M, APB.L, APB.U, APB.UM, APB.UL

#### STANDARD CONFIGURATIONS

##### Configuration 1 (Default)

Left Chest      Right Chest  
 4-way Grommets    Name Tape Loop  
 3x3 Badge Loop

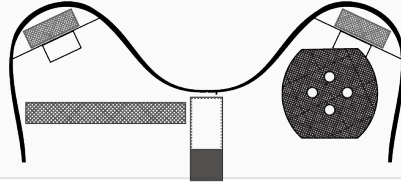

##### Configuration 2

Left Chest      Right Chest  
 4-way Grommets    Name Tape Loop

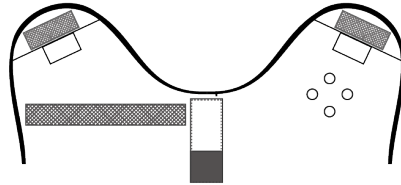

##### Configuration 3

Left Chest      Right Chest  
 Blank                Name Tape Loop

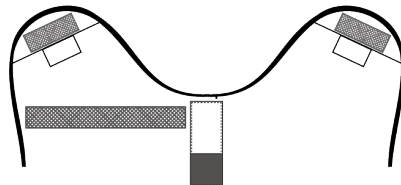

##### Configuration 4

Left Chest      Right Chest  
 4-way Grommets    Blank

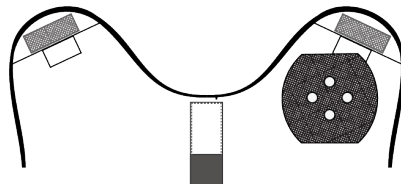

##### Configuration 5

Left Chest      Right Chest  
 4-way Grommets    Blank

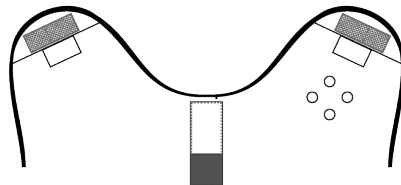

##### Configuration 6

Left Chest      Right Chest  
 Blank                Blank

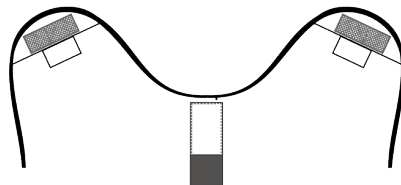

##### Configuration 7

Left Chest      Right Chest  
 4-way Grommets    Name Tape Loop  
 Shield Shape Loop

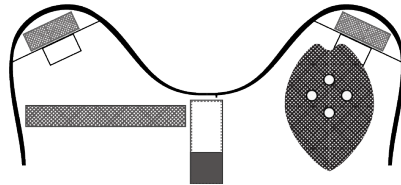

##### Configuration 8

Left Chest      Right Chest  
 4-way Grommets    Blank  
 Shield Shape Loop

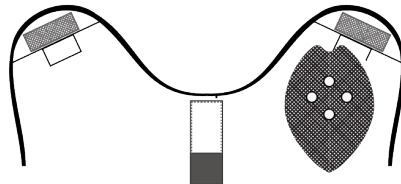

#### REMOVABLE FEATURES

There is 1 removable feature for APB Carriers: Rear ID Loop  
 To remove a feature from your configuration, please use the following notations.

No Rear ID Loop = **NRL**

NO Rear ID Loop

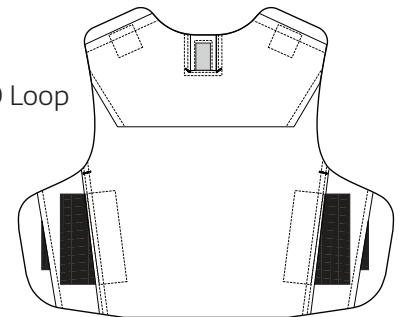

Ex. Configuration 4, NRL

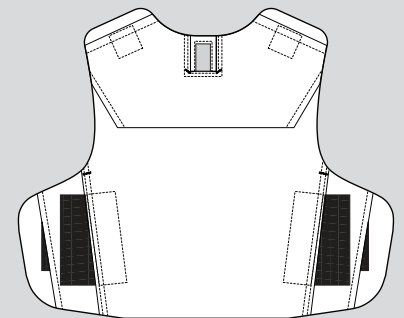
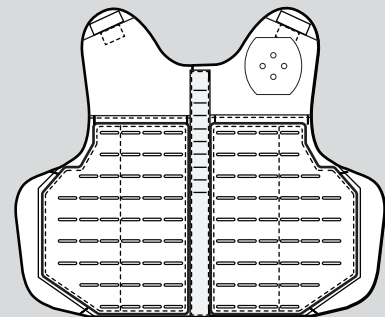



## PRODUCT COMPONENTS

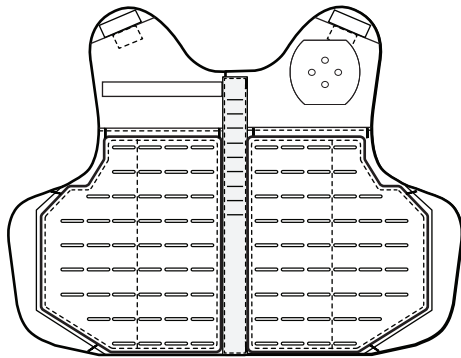

CARRIER FRONT

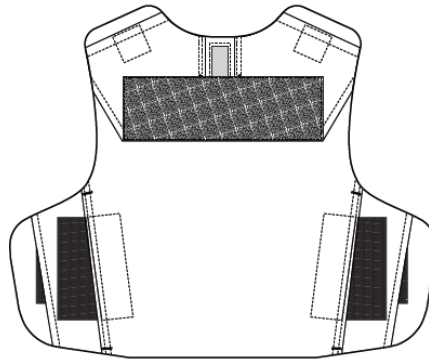

CARRIER BACK

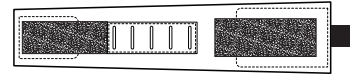
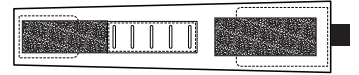

SHOULDER STRAPS

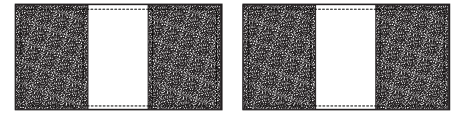

SIDE CLOSURE STRAPS

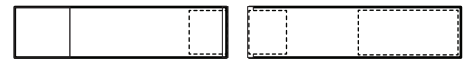

BELLYBANDS

## COLORWAYS

Carrier	Black	Dark Navy	Ranger Green	Coyote	Wolf Grey	Tan 499	Brown	Spruce Green	Tactical Green
Trim	Black	Black	Ranger Green	Coyote	Wolf Grey	Tan 499	Brown	Black	Tactical Green
MOLLE	Black	Black	Ranger Green	Coyote	Wolf Grey	Tan 499	Black	Black	Tactical Green
Laser-Cut	Black	Dark Navy	Ranger Green	Coyote	Wolf Grey	Tan 499	Black	Black	Tactical Green
Swatch									

## PLATE POCKET RESTRICTIONS

Key:  5x7", 5x8", 7x9"  
 5x7", 5x8", 7x9", 8x10"

5x7", 5x8", 7x9", 8x10", 10x12"

		Front *Applicable to Male Sizes										
		Girth	16	18	20	22	24	26	28	30	32	34
Length	10	10	10	10	11	11	11	11	12	12		
	11	11	11	11	12	12	12	12	13	13		
	12	12	12	12	13	13	13	13	14	14		
	13	13	13	13	14	14	14	14	15	15		
	14	14	14	14	15	15	15	15	16	19		
	15	15	15	15	16	16	16	16	17	17		
	16	16	16	16	17	17	17	17	18	18		
	17	17	17	17	18	18	18	18	19	19		

		Back *Applicable to Male Sizes										
		Girth	16	18	20	22	24	26	28	30	32	34
Length	12	12	12	12	13	13	13	13	14	14		
	13	13	13	13	14	14	14	14	15	15		
	14	14	14	14	15	15	15	15	16	16		
	15	15	15	15	16	16	16	16	17	17		
	16	16	16	16	17	17	17	17	18	18		
	17	17	17	17	18	18	18	18	19	19		
	18	18	18	18	19	19	19	19	20	20		
	19	19	19	19	20	20	20	20	21	21		