

TCX.L

TACTICAL CUMMERBUND GEN-X LASER-CUT



- Accepts GH concealable panels
- External tactical carrier with laser-cut MOLLE on front, rear (optional), and cummerbund
- External 360° adjustable cummerbund that accepts optional soft armor inserts
- Durable 500 Cordura Nylon outer materials
- Dual discrete chest pockets and dual discrete lower pockets for added storage
- Optional horizontal and vertical badge grommets on wearer's left chest
- Optional 3x3" or shield shape loop for badge attachment on wearer's left chest
- Optional 1" loop for name tape on wearer's right chest
- Optional front 3x10" MOLLE loop and rear 3x10" loop for ID attachment (IDs sold separately)
- Front internal, bottom-loading plate pockets accept 5x8", 7x9", 8x10", and 10x12" special threat and hard armor plates (size restrictions apply)
- Rear external, top-loading plate pockets accept 5x8", 7x9", 8x10" and 10x12" special threat and hard armor plates (size restrictions apply)
- Rear telescoping drag strap for emergency extraction
- Overlapping shoulder closures and mic tab at center chest
- Internal cummerbund for secure fit
- Easy and secure body-side panel access
- Ballistic suspension for proper panel alignment prevents sagging and curling

COLORS



BLACK



DARK NAVY



RANGER GREEN



COYOTE



BROWN



WOLF GREY



TAN 499



TACTICAL GREEN



RED

FEATURES



BACK



SIDE

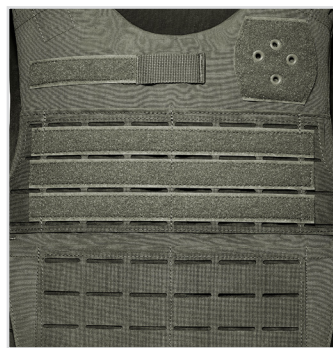

MOLLE LOOP



BADGE LOOP

TCX CARRIERS: TCX.M, TCX.L, TCX.MT, TCX.LT

TCX.M

 Tactical Cumberbund Carrier
Gen-X, MOLLE

TCX.L

 Tactical Cumberbund Carrier
Gen-X, Laser-Cut MOLLE

TCX.MT

 Tactical Cumberbund Carrier
Gen-X, MOLLE Tubes

TCX.LT

 Tactical Cumberbund Carrier
Gen-X, Laser-Cut MOLLE Tubes

How to order a TCX Style Carrier

There are 8 standard configurations for embellishments for TCX carriers.

There are 3 removable features for TCX Carriers: Front ID Loop, Rear ID Loop and Rear MOLLE (refers to traditional MOLLE webbing and/or laser-cut webbing.)

**Configuration 1
(Default)**
Left Chest
4-way Grommets
3x3 Badge Loop

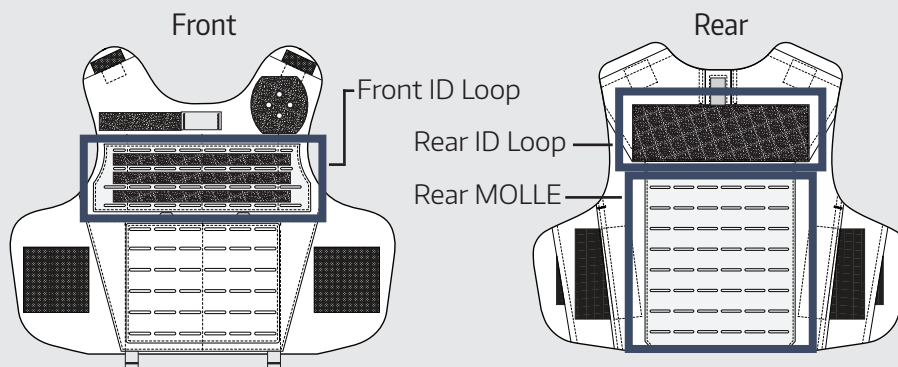
Right Chest
Name Tape Loop

 Front ID Loop,
Rear ID Loop, and
Rear MOLLE are default
features that can be
removed.

 No Front ID Loop = NFL
No Rear ID Loop = NRL
No Rear MOLLE = NRM

Please note your desired carrier configuration on the PO.

Ex. TCX.LT (Black, Configuration 2, NFL and NRM) John Smith, size 2413/2415

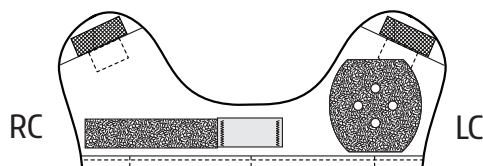
If no configuration is selected at time of order, the carrier will be entered with Configuration 1, All Features.

Embellishment Details

 Left Chest and Right Chest notations
are viewed as the wearer's left chest
and wearer's right chest.

Name Tape: Male 1x4", Female 1x4"

Badge Loop: 3x3" with curved edges,
3x3" oval shape

Grommets: 1.25" apart on center

ID Loop: Male 3x10", Female 3x9"

TCX CARRIERS: TCX.M, TCX.MT, TCX.L, TCX.LT

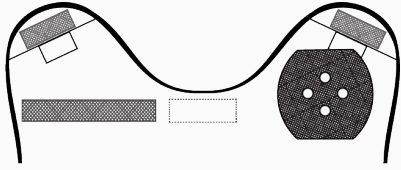
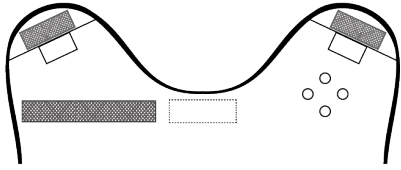
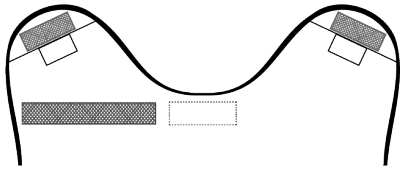
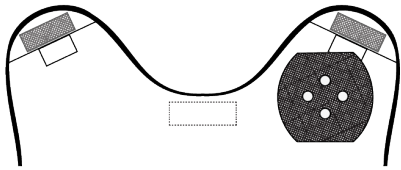
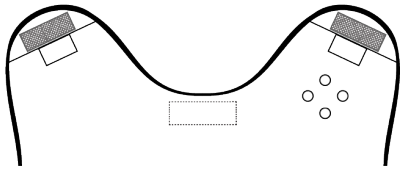
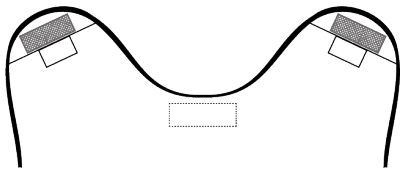
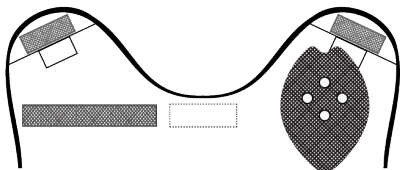
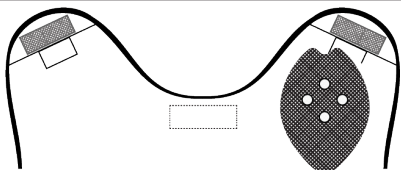
STANDARD CONFIGURATIONS	
Configuration 1 (Default)	
<u>Left Chest</u> 4-way Grommets 3x3" Badge Loop	<u>Right Chest</u> Name Tape Loop
	
Configuration 2	
<u>Left Chest</u> 4-way Grommets	<u>Right Chest</u> Name Tape Loop
	
Configuration 3	
<u>Left Chest</u> Blank	<u>Right Chest</u> Name Tape Loop
	
Configuration 4	
<u>Left Chest</u> 4-way Grommets 3x3" Badge Loop	<u>Right Chest</u> Blank
	
Configuration 5	
<u>Left Chest</u> 4-way Grommets	<u>Right Chest</u> Blank
	
Configuration 6	
<u>Left Chest</u> Blank	<u>Right Chest</u> Blank
	
Configuration 7	
<u>Left Chest</u> 4-way Grommets Shield Shape Loop	<u>Right Chest</u> Name Tape Loop
	
Configuration 8	
<u>Left Chest</u> 4-way Grommets Shield Shape Loop	<u>Right Chest</u> Blank
	

REMOVABLE FEATURES

There are 3 removable features for TCX Carriers: Front ID Loop, Rear ID Loop and Rear MOLLE (refers to traditional MOLLE webbing and/or laser-cut webbing.)

To remove a feature from your configuration, please use the following notations.

- No Front ID Loop = **NFL**
- No Rear ID Loop = **NRL**
- No Rear MOLLE = **NRM**

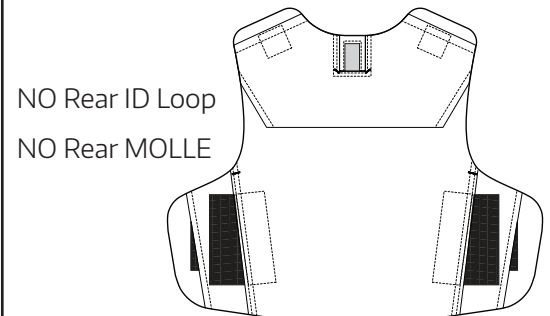
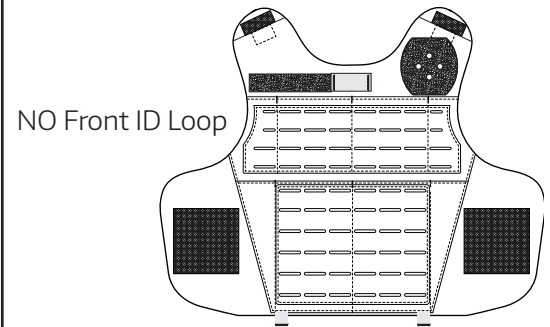

Ex. Configuration 3, NFL, NRM

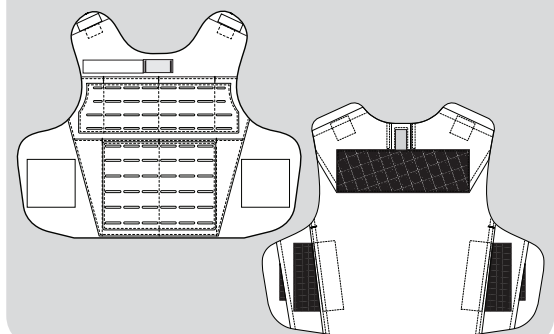

PRODUCT COMPONENTS

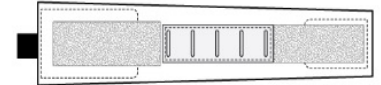
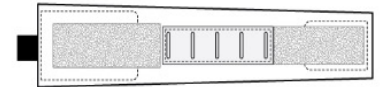
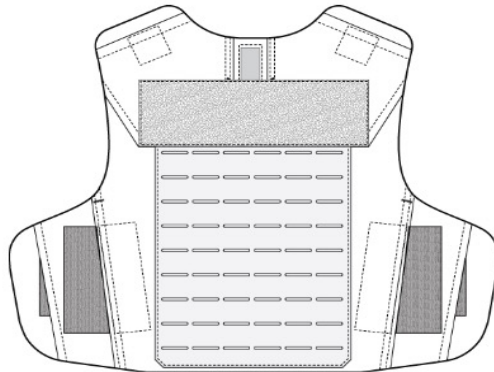
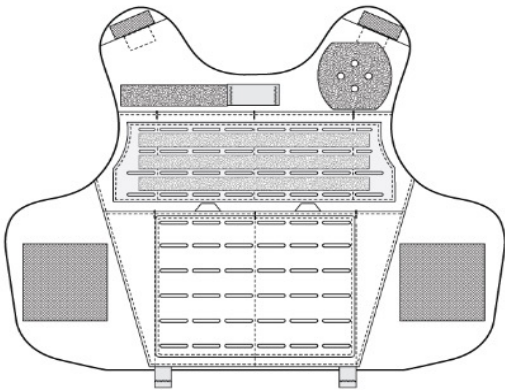

SHOULDER STRAPS

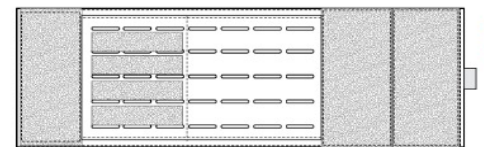
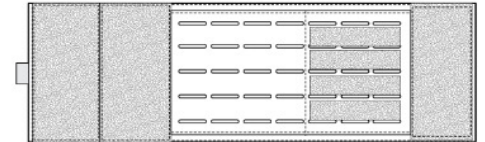

CUMMERBUNDS



BELLY BANDS

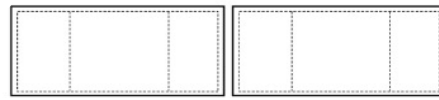

SIDE CLOSURE STRAPS

Male cummerbunds grade between 6-8" in height.
Female cummerbunds are 6" in height.

COLORWAYS

Carrier	Black	Dark Navy	Ranger Green	Coyote	Wolf Grey	Tan 499	Tactical Green	Red	Brown
Trim	Black	Black	Ranger Green	Coyote	Wolf Grey	Tan 499	Tactical Green	Black	Brown
Laser-Cut	Black	Dark Navy	Ranger Green	Coyote	Wolf Grey	Tan 499	Tactical Green	Red	Black
Swatch									

PLATE POCKET RESTRICTIONS

Key: 5x7", 5x8", 7x9"
 5x7", 5x8", 7x9", 8x10"

5x7", 5x8", 7x9", 8x10", 10x12"

Front *Applicable to Male Sizes

Girth	16	18	20	22	24	26	28	30	32	34
Length										

Back *Applicable to Male Sizes

Girth	16	18	20	22	24	26	28	30	32	34
Length										